

# Quick Installation Guide

ASW75K-LT/ASW80K-LT/ASW100K-LT/ASW110K-LT



Android



ios



# 1 GENERAL INFORMATION

This quick installation guide does not replace the description in the comprehensive operating instructions.

The contents of this guide may be updated or revised due to product development. The information in this guide is subject to change without notice. The latest version of this document and the comprehensive manual for installation, commissioning, configuration and decommissioning are to be found in PDF format at [www.solplan-et.net](http://www.solplan-et.net).

# 2 SAFETY

## 2.1 Intended use

The product is a transformerless PV inverter which converts the direct current of the PV generator into grid-compatible single-phase alternating current and then feeds the single-phase alternating current into the public power grid.

The product is intended for indoor and outdoor applications.

The product must only be connected with PV modules of protection class II (in accordance with IEC 61730, application class A). PV modules with a high capacitance to ground must only be used if their capacity does not exceed 5 $\mu$ F. Do not connect any sources of energy other than PV modules to the product.

The product is not equipped with an integrated transformer and therefore has no galvanic isolation. The product must not be operated with PV modules whose outputs are grounded. This can cause the product to be destroyed. The product may be operated with PV modules whose frame is grounded.

All components must remain within their permitted operating ranges and their installation requirements at all times.

Use the product only in accordance with the information provided in the operating instructions and with the locally applicable standards and directives. Any other application may cause personal injury or property damage.

The product must only be used in countries for which it is approved or released by AISWEI and the grid operator.

The type label must be permanently attached to the product and must be in legible condition.

This document does not replace any regional, state, provincial, federal or national laws, regulations or standards that apply to the installation, electrical safety and use of the product.

## 2.2 Important safety instructions

The product has been designed and tested strictly according to the international safety requirements. As with all electrical or electronical devices, there are residual risks despite careful construction. To prevent personal injury and property damage and to ensure long-term operation of the product, read this section carefully and observe all safety information at all times.

### DANGER

#### **Danger to life due to high voltages of the PV array!**

When exposed to sunlight, the PV array generates dangerous DC voltage which is present in the DC conductors and the live components of the product. Touching the DC conductors or the live components can lead to lethal electric shocks. If you disconnect the DC connectors from the product under load, an electric arc may occur leading to electric shock and burns.

- Do not touch non-insulated cable ends.
- Do not touch the DC conductors.
- Do not touch any live components of the product.
- Do not open the product.
- All work on the product must only be carried out by qualified personnel who have read and fully understood all safety information contained in this document and the operating instructions.
- Disconnect the product from voltage sources and ensure it cannot be reconnected before working on the product.
- Wear suitable personal protective equipment for all work on the product.

## DANGER

Danger to life due to electric shock when touching live system components in case of a ground fault!

If a ground fault occurs, parts of the system may still be live. Touching live parts and cables results in death or lethal injuries due to electric shock.

- Disconnect the product from voltage sources and ensure it cannot be reconnected before working on the device.
- Only touch the cables of the PV modules on their insulation.
- Do not touch any parts of the substructure or frame of the PV array.
- Do not connect PV strings with ground faults to the product.

## WARNING

Danger to life due to electric shock from destruction of the measuring device due to overvoltage!

Overvoltage can damage a measuring device and result in voltage being present in the enclosure of the measuring device. Touching the live enclosure of the measuring device results in death or lethal injuries due to electric shock.

- Only use measuring devices with a DC input voltage range of or higher.

## CAUTION

Risk of burns due to hot enclosure parts.

Some parts of the enclosure can get hot during operation.

- During operation, do not touch any parts other than the enclosure lid of the product.

## CAUTION

Risk of injury due to weight of product .

Injuries may result if the product is lifted incorrectly or dropped while being transported or mounted.

- Transport and lift the product carefully. Take the weight of the product into account.
- Wear suitable personal protective equipment for all work on the product.

## 2.3 Symbols on the label



Beware of a danger zone

This symbol indicates that the inverter must be additionally grounded if additional grounding or equipotential bonding is required at the installation site.



Beware of high voltage and operating current

The inverter operates at high voltage and current. Work on the inverter must only be carried out by skilled and authorized electricians.



Beware of hot surfaces

The inverter can get hot during operation. Avoid contact during operation.



Capacitor discharge

Danger to life due to high voltages in the inverter. Do not touch live parts for 25 minutes after disconnection from the power sources.



Observe the documentation

Observe all documentation supplied with the product.

## 3 EU DECLARATION OF CONFORMITY

Within the scope of the EU directives

- Radio Equipment Directive 2014/53/EU (L 153/62-106. May 22. 2014) (RED)

- Restriction of the use of certain hazardous substances 2011/65/EU (L 174/88, June 8, 2011) and 2015/863/EU (L 137/10, March 31, 2015) (RoHS)

confirms herewith that the products described in this document are in compliance with the fundamental requirements and other relevant provisions of the above mentioned directives. The entire EU Declaration of Conformity can be found at [www.solplanet.net](http://www.solplanet.net).



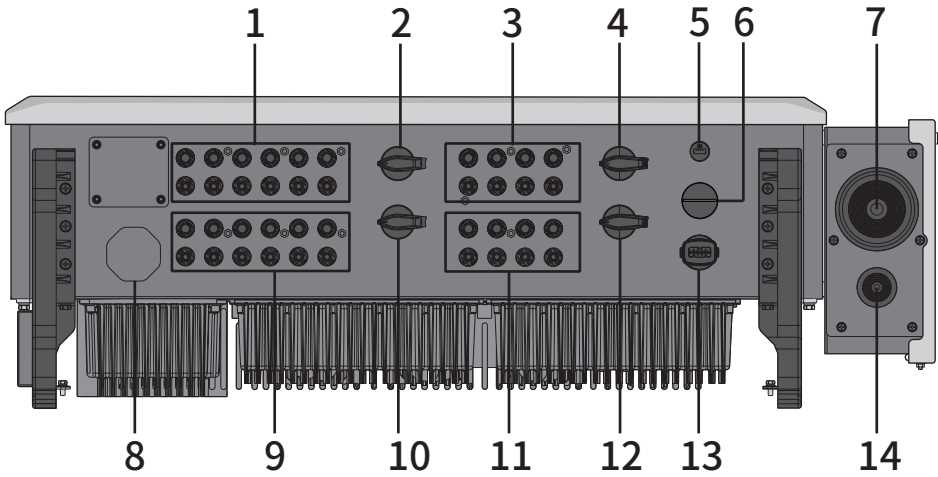

1 DC connector 1-6 pair (Controlled by DC switch 1)

2 DC switch 1

3 DC connector 13-16 pair (Controlled by DC switch 3)

4 DC switch 3

5 WiFi stick port

6 The reserved terminal

7 AC threading hole

8 Lock valve

9 DC connector 7-12 pair (Controlled by DC switch 2)

10 DC switch 2

11 DC connector 17-20 pair (Controlled by DC switch 4)

12 DC switch 4

13 RS485 Communication port

14 Reserved grounding port

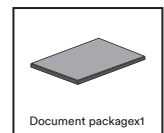
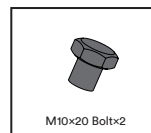
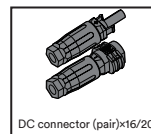
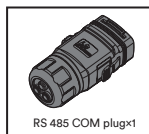
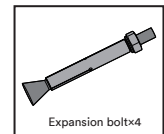
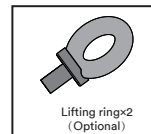
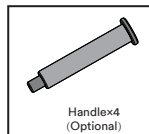
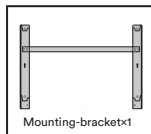
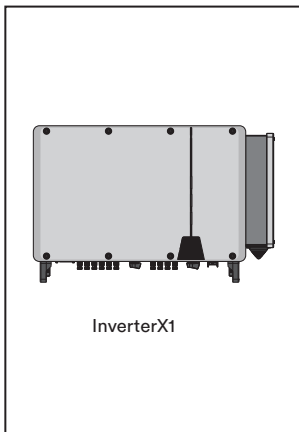

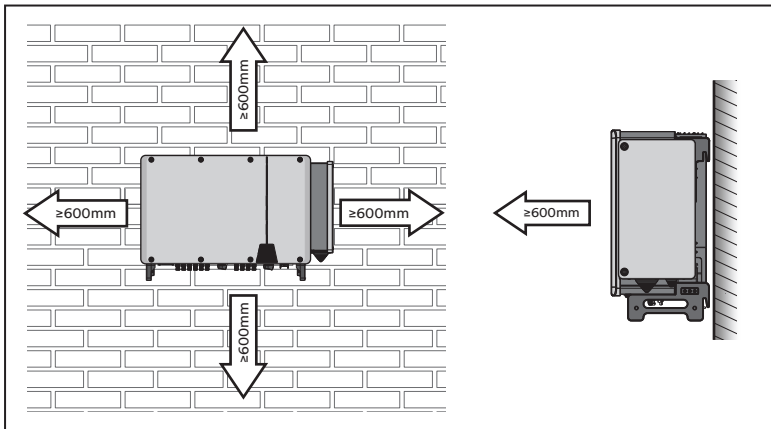
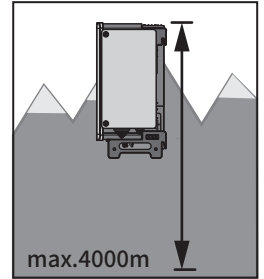
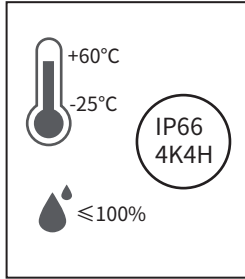
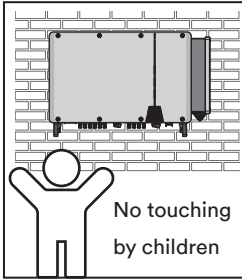
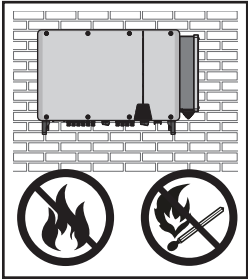
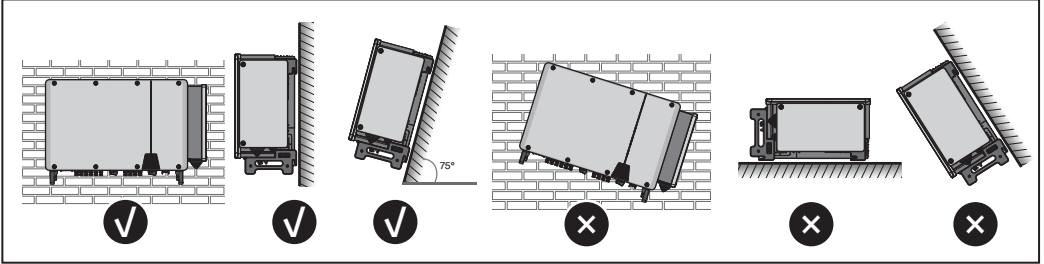
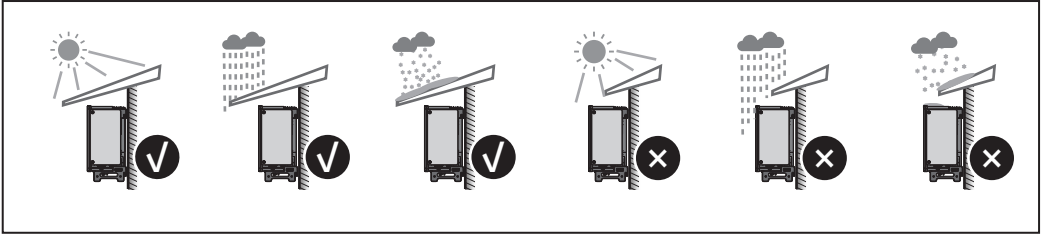



Unit:mm

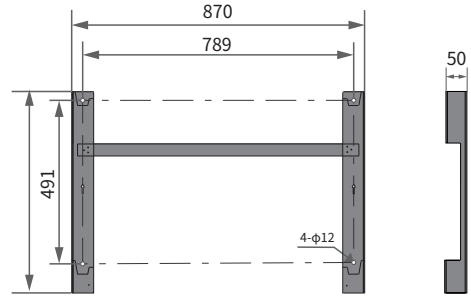
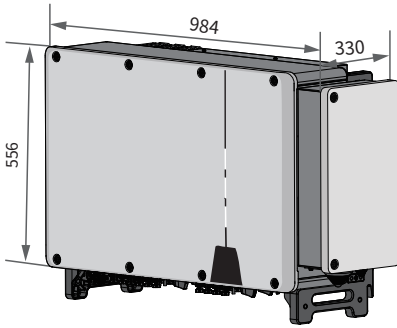

### 8.1 Moving the inverter (Optional)

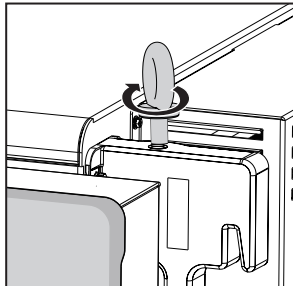
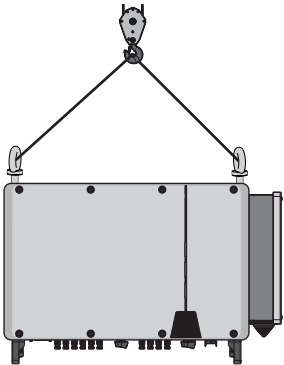
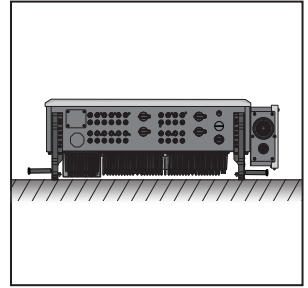
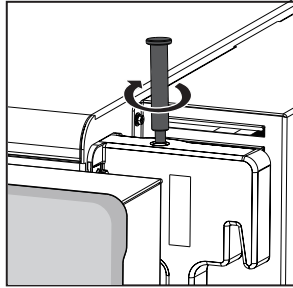
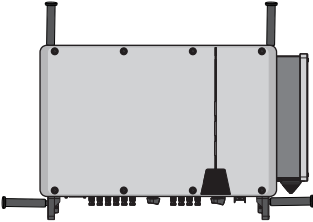

## 8.2 Mounting-bracket

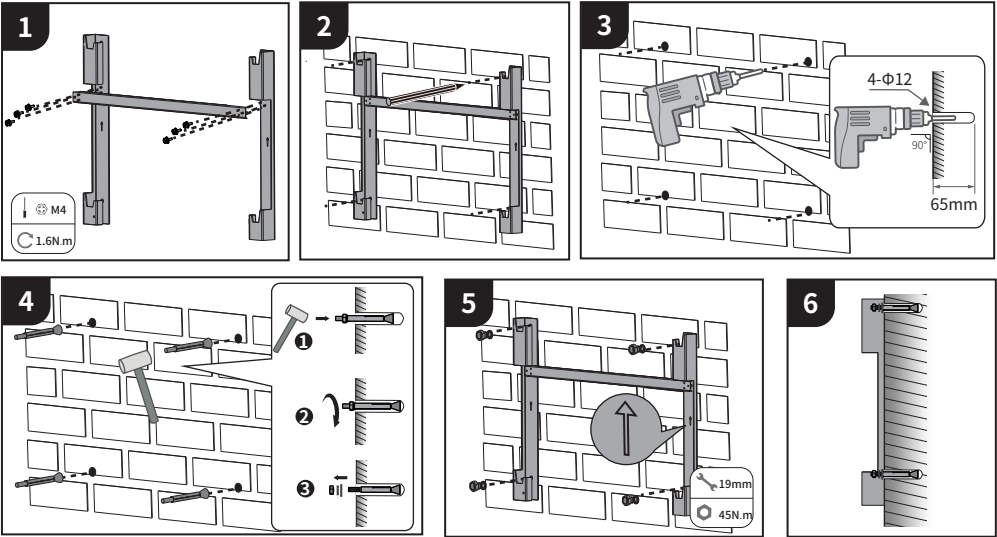

## 8.3 Wall-Mounted Installation

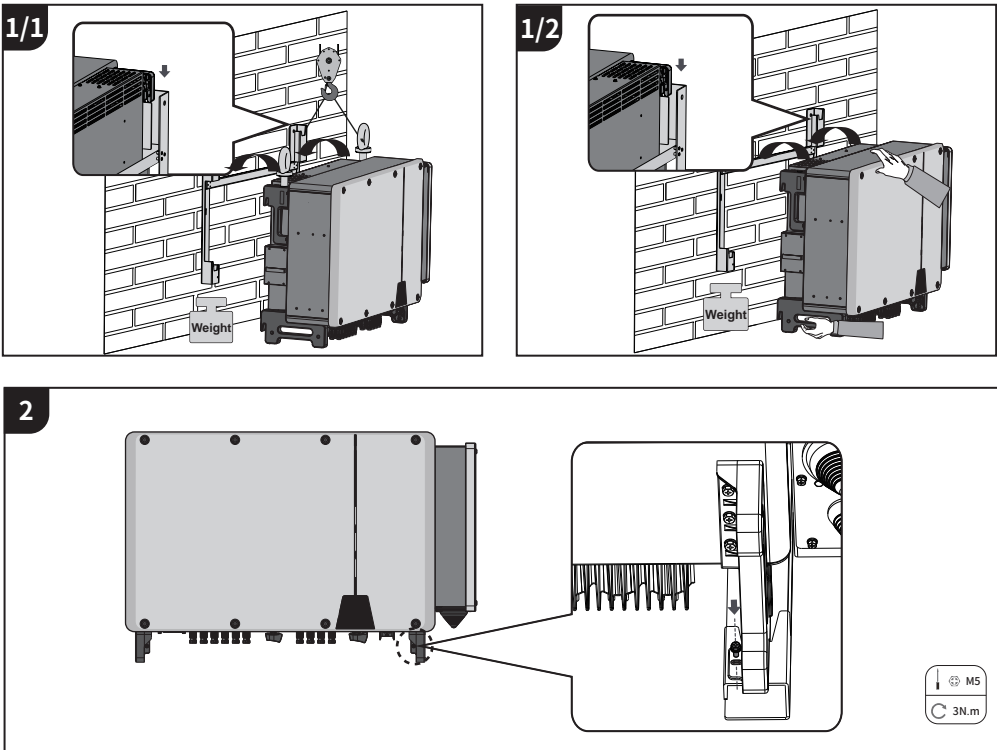

# 9 SECOND PROTECTIVE GROUNDING

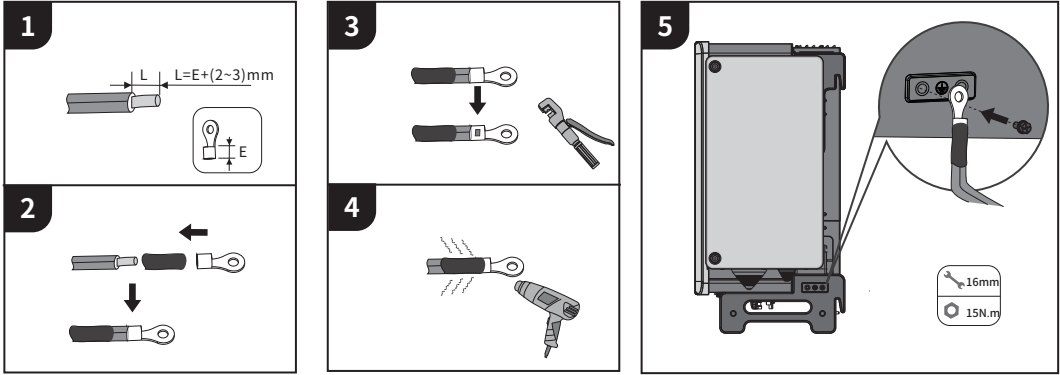

# 10 AC CONNECTION

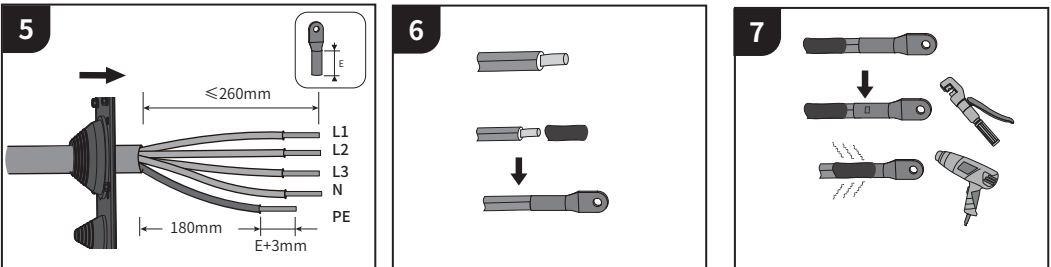
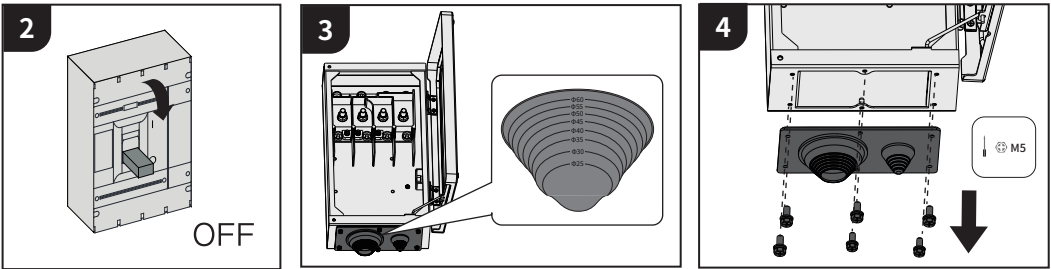
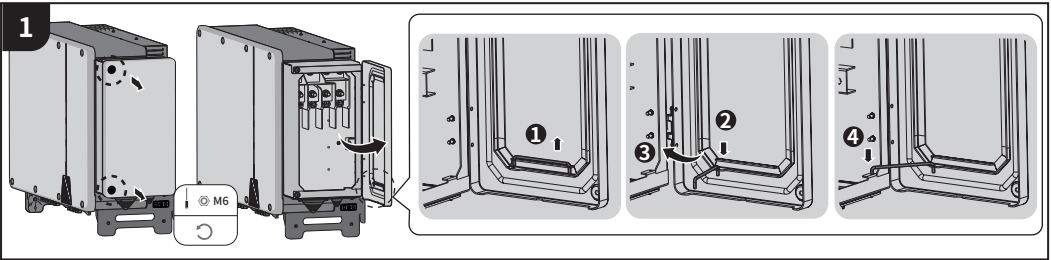

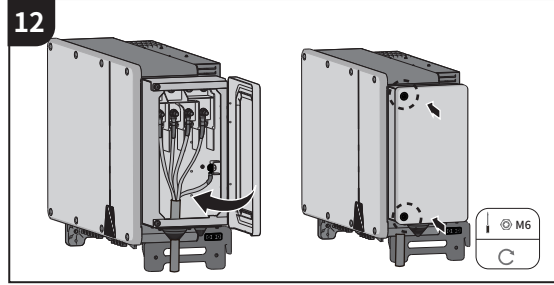
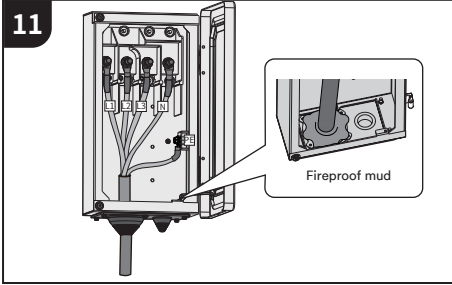
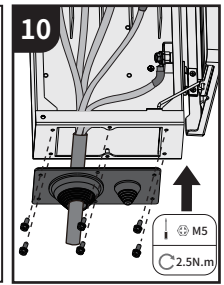
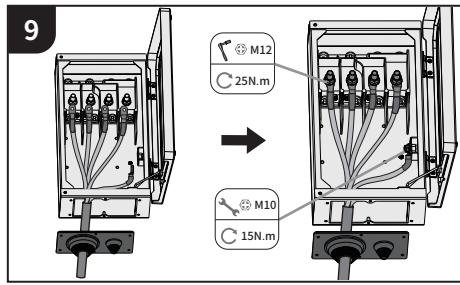
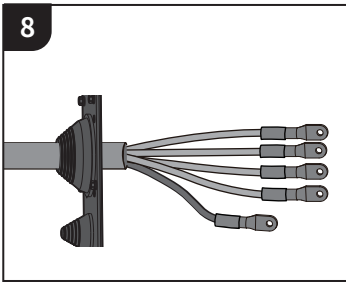

## 11 DC CONNECTION

### TYPE 1

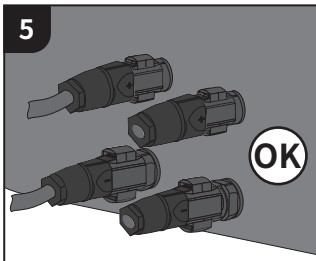
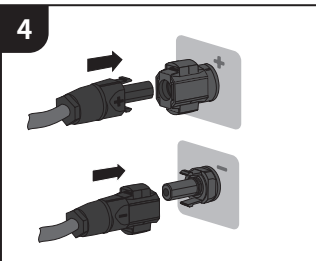
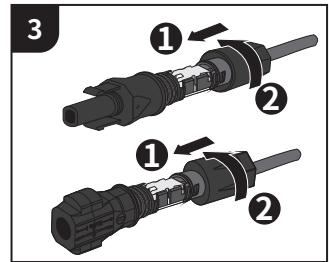
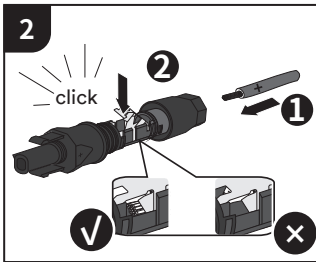
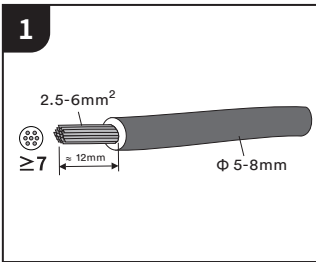

# TYPE 2

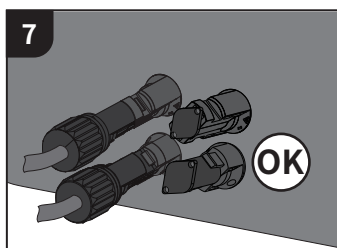
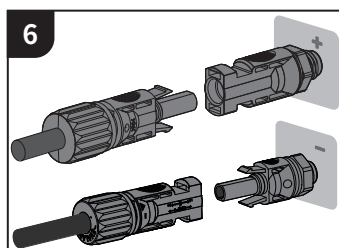
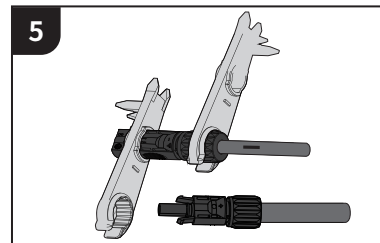
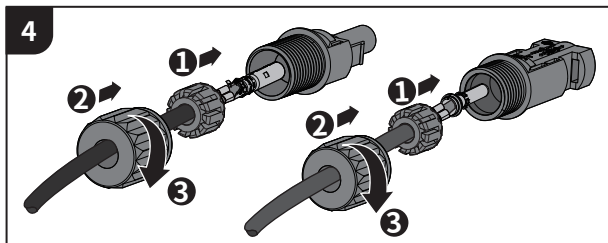
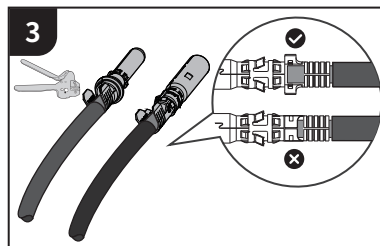
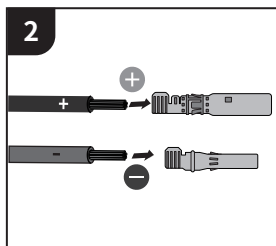
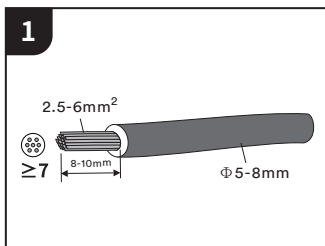

12.1 RS485 cable connection

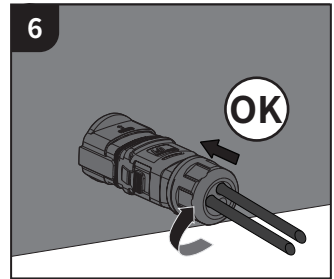
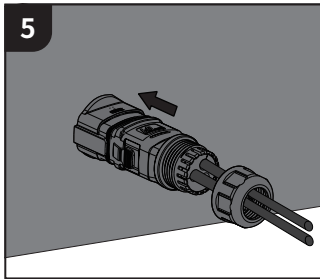
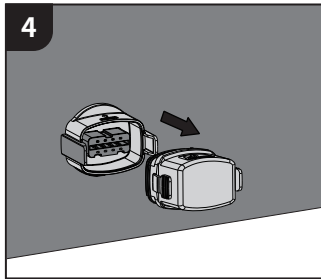
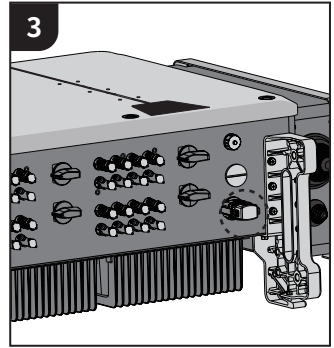
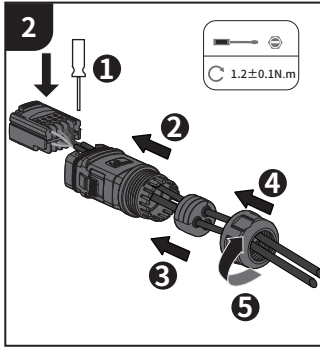
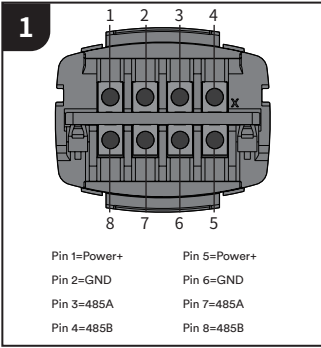

12.2 WiFi/4G stick connection

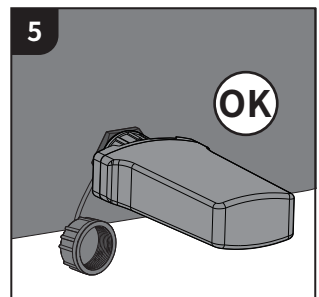
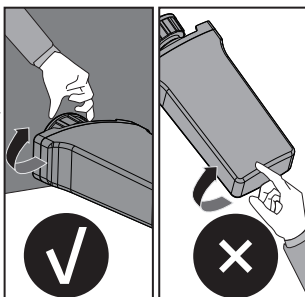
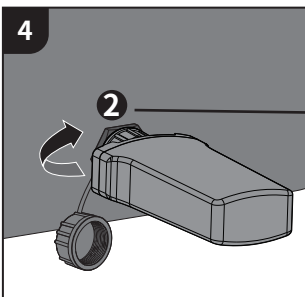
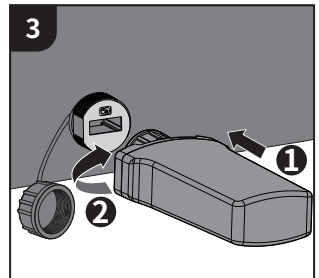
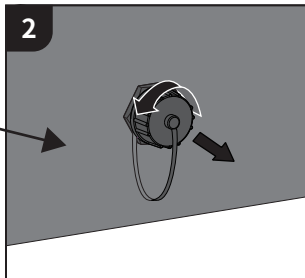
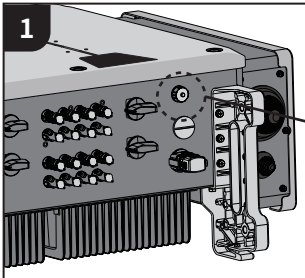

Please contact our Service Department if you have any technical questions about our products.

The following information is needed to provide necessary assistance:

- Inverter model
- Inverter serial number
- Photovoltaic module model
- Photovoltaic modules number and strings number connected to each MPPT
- Fault code
- Installation location
- Warranty card

## EMEA

Service email: [service.EMEA@solplanet.net](mailto:service.EMEA@solplanet.net)

## APAC

Service email: [service.APAC@solplanet.net](mailto:service.APAC@solplanet.net)

## LATAM

Service email: [service.LATAM@solplanet.net](mailto:service.LATAM@solplanet.net)

## Aiswei Greater China

Service email: [service.china@aiswei-tech.com](mailto:service.china@aiswei-tech.com)

Hotline: +86 400 801 9996

## Taiwan

Service email: [service.taiwan@aiswei-tech.com](mailto:service.taiwan@aiswei-tech.com)

Hotline: +886 809089212

<https://solplanet.net/contact-us>

Scan QR code:



Android

Scan QR code:



ios







AISWEI Technology(Shanghai) Co., Ltd.