

## 4G Kit-EC&4G Kit-AU Quick Installation Guide

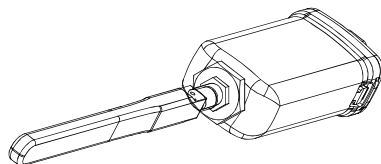

Revision: 01  
Date: 2022-01-30

340-00652-00

**NOTE** These instructions will be updated from time to time due to product version upgrades or for other reasons. Unless otherwise specified, they are not a substitute for the safety instructions given on product labels or in user manuals. All descriptions in the document are intended only as user instructions.

### 01 Technical Data

Module	4G Kit-EC	4G Kit-AU
Power supply(V)		5V
Self-consumption (W)		< 4W
Operating temperature		-30°C to +60°C
Operating humidity		0–100% RH
Altitude		≤4000m
Size (LxWxH)		96mm x 49mm x 32mm
Protection class		IP65
Standard SIM card size		25mm*15mm
Certification	CE	RCM
Wireless parameters	LTE-FDD: B1/B3/B7/B8/B20/B28A WCDMA: B1/B8 GSM/GPRS: B3/B8	LTE-FDD: B1/B3/B7/B8/B20/B28A LTE-TDD: B40 WCDMA: B1/B2/B5/B8 GSM/GPRS: B3/B8
Transmission speed	LTE-FDD(Mbps): 150 (DL)/ 50 (UL) WCDMA(Kbps): 384 (DL)/ 384 (UL) GPRS(Kbps): 107 (DL)/ 85.6 (UL)	LTE-FDD(Mbps): 150 (DL)/ 50 (UL) LTE-TDD(Mbps): 130 (DL)/ 30 (UL) WCDMA(Kbps): 384 (DL)/ 384 (UL) GPRS(Kbps): 107 (DL)/ 85.6 (UL)

### 02 Applications

**NOTE** Information regarding the SIM operators, inverter models and versions supported by 4G modules will be updated from time to time, and the latest support details can be obtained by scanning the QR code. Download the latest version of SolarGo and SEMS Portal APP from Google Play or App Store.



#### Near-Field Bluetooth Configuration with APN

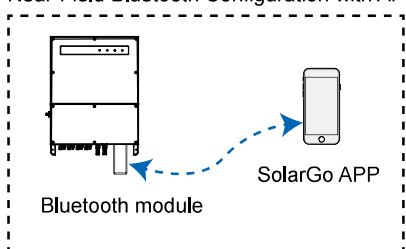

#### 4G Communication Networking

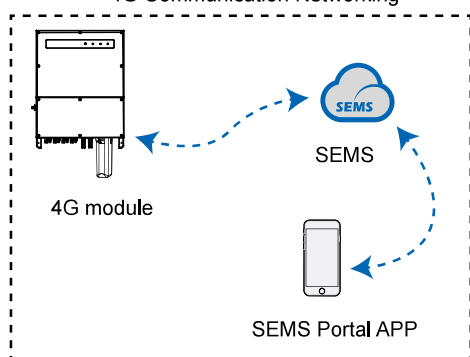

### 03 Installation and Commissioning

#### Installing Bluetooth module



- When installing the Bluetooth and 4G modules, make sure the inverter is powered off.
- During installation, wear antistatic gloves, and take electrostatic protection measures.

- Check that the items delivered are correct.
  - 1 x 4G module
  - 1 x Bluetooth module
  - 1 x 4G antenna
  - 1 x Removing tool
  - 1 x 5-pin USB adapter
  - 1 x Quick Installation Instructions
  - 4 x M3 screws

- (Optional) Install the 5-pin USB adapter for the inverter. If the inverter uses a 5-pin interface for communication, perform this step.

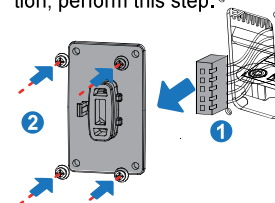

- Install Bluetooth module.

#### USB Communication Interface

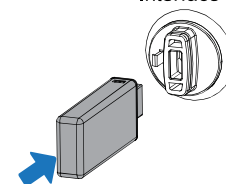

#### Setting APN parameters



Before setting the parameters, make sure that:

- The inverter is powered on.
- Communication is functioning properly between Bluetooth module and inverter.
- The SolarGo APP has been downloaded from Google Play or App Store. (SolarGo with V3.0.2 or newer version in Android system or with V3.0.1 or newer version in iOS system is required.)
- The procedure is basically identical for Android and iOS operating systems, with only slight difference between the interfaces. These instructions use the Android operating system as an example.
- Please use the initial password when logging in for the first time, and change it as soon as possible to one that is memorable for you. To keep your account secure, it is recommended to change your password regularly.



SolarGo APP



Currently no device

Please click on the button below to connect the device

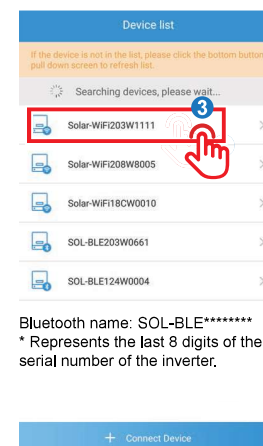
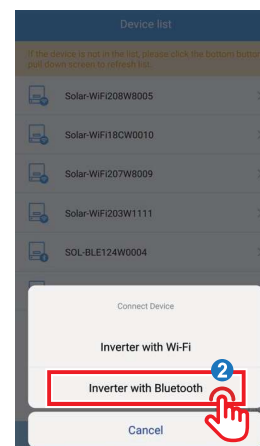

Bluetooth name: SOL-BLE\*\*\*\*\*  
\* Represents the last 8 digits of the serial number of the inverter.

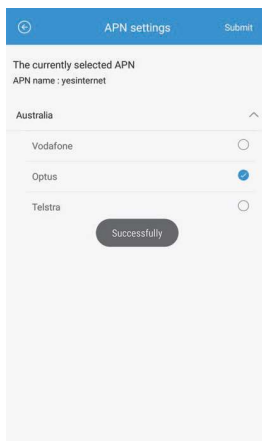
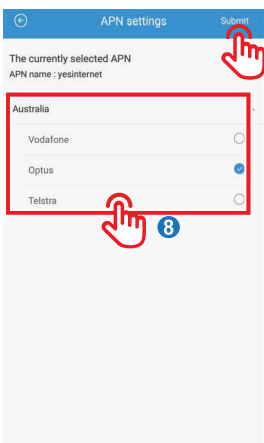
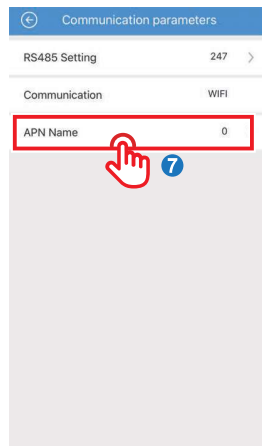
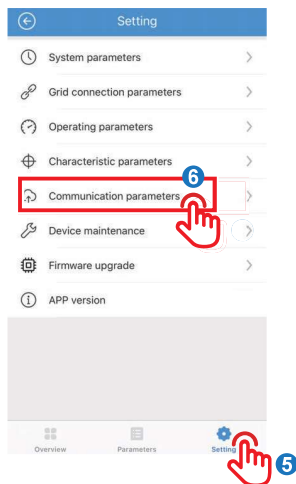
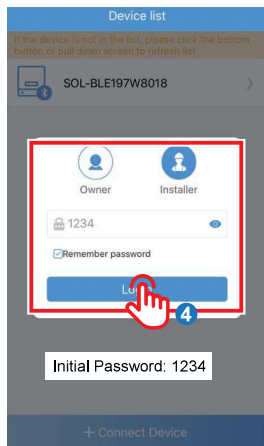

### Powering on the device

1. Power on the inverter, thus powering on the 4G module.
2. Observe the status of the indicators on the 4G module and the inverter. (When the communication indicator on the inverter is ON continuously, it means that communication is functioning properly. For other indicator status, refer to the User Manual of the relevant inverter model.)

Indicator	Colour	Status	Notes	Description
Power	Green	ON continuously	Normal	Module powered on
		OFF	Abnormal	Module not powered on
Communication	Blue	Flashing slowly (On for 0.2s, Off for 1.8s)	Normal	Searching for connections
			Abnormal	Staying off for 15 seconds after illuminating, which indicates the SIM card is not inserted or it has a loose connection. Insert the SIM card, or remove it and then re-insert.
		Flashing slowly (On for 1.8s, Off for 0.2s)	Normal	Standby
			Abnormal	If the indicator stays in this state for an extended period (more than 5 minutes), the APN is set incorrectly, the SIM card has no signal, the signal strength is weak, or there is no data. Please check the APN information and reset the APN parameters on the SolarGo APP. Contact the operator to verify the SIM card signal. Check whether the SIM card credit and data are sufficient. If not, please top up.
		Flashing rapidly (On for 0.125s, Off for 0.125s)	Normal	Data uploading

### Installing 4G module



- When installing the Bluetooth and 4G modules, make sure the inverter is powered off.
- During installation, wear antistatic gloves, and take electrostatic protection measures.

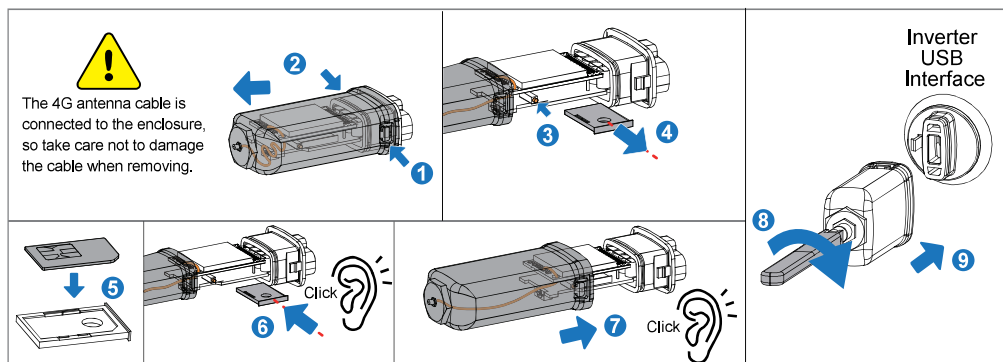

### 04 Device Replacement

1. Before replacing the 4G module, check that the inverter is powered down, and the new 4G module is ready for installation.
2. Use the special tool supplied to remove 4G module.
3. (Optional) If SIM card is bound to an existing device, consult the operator to unbind it.
4. Install the new 4G module.
5. Power on the inverter.

